

SECTION B-B

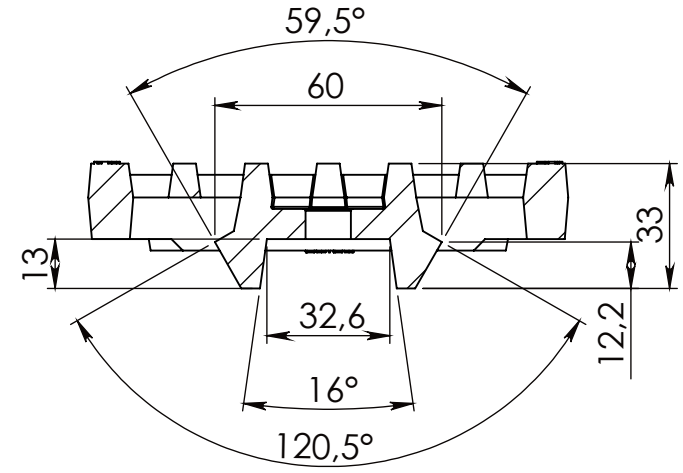

SECTION C-C

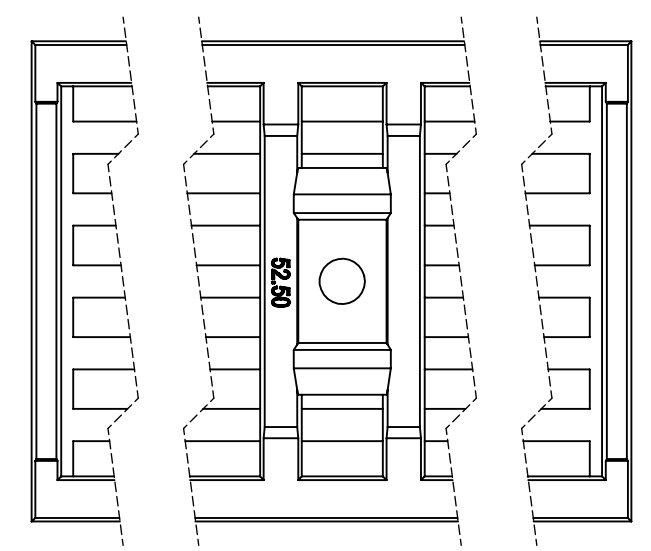

VIEW G

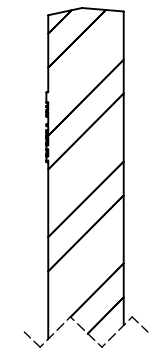
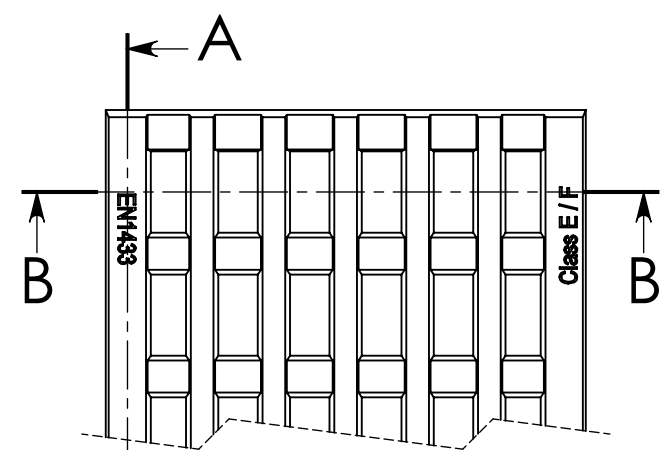

SECTION A-A

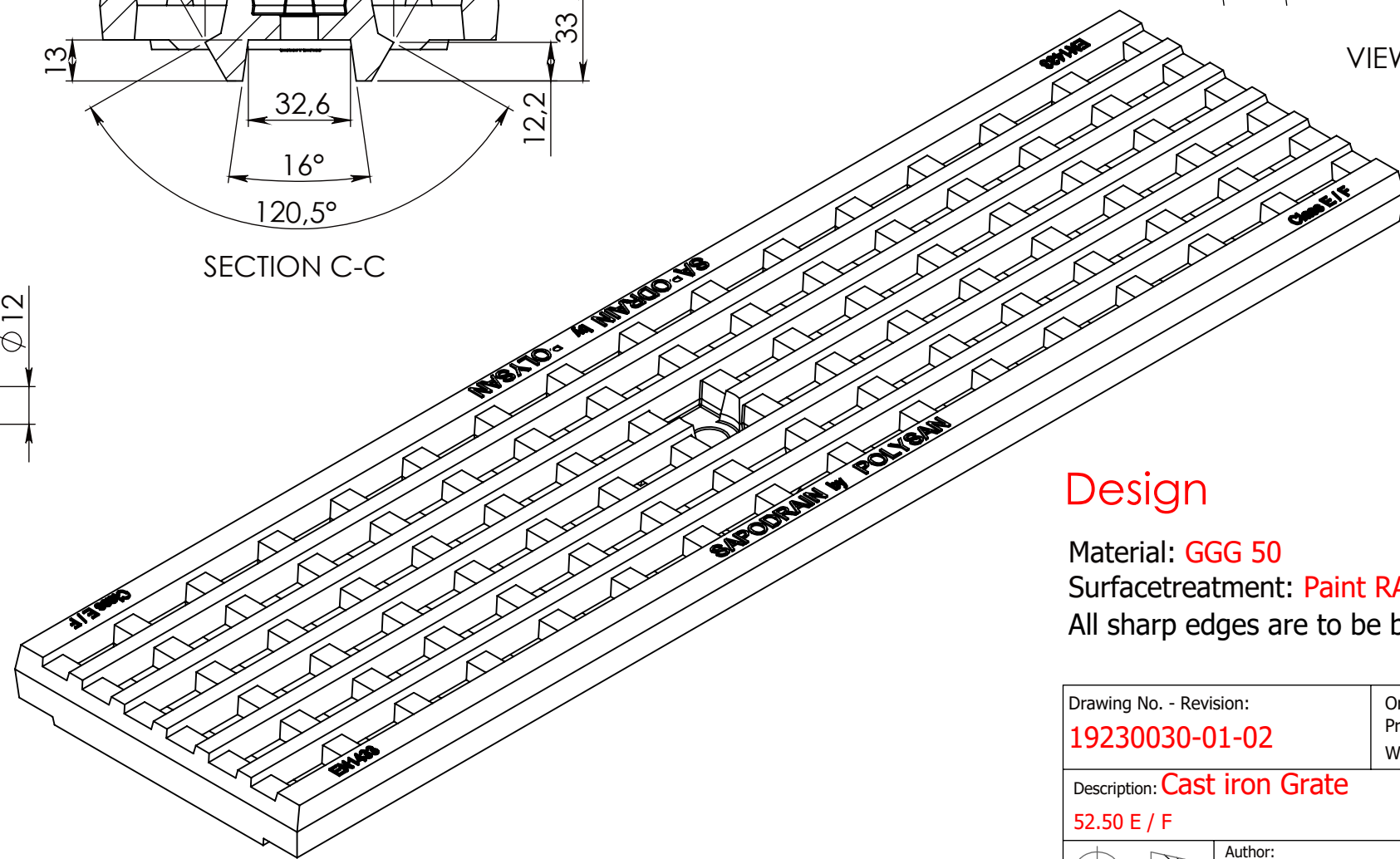
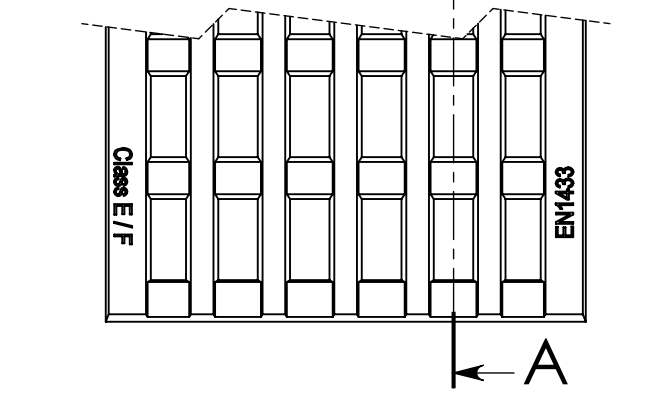
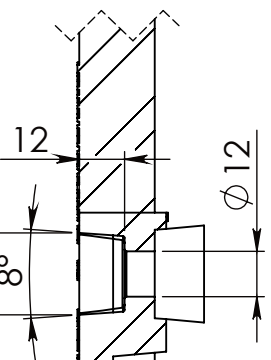
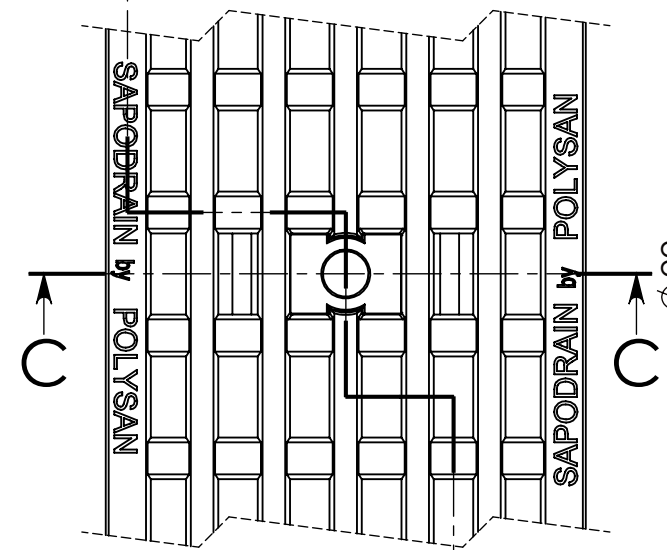

Design

Material: **GGG 50** Amount.: **1**
 Surfacetreatment: **Paint RAL9005**
 All sharp edges are to be broken

Drawing No. - Revision: 19230030-01-02		Order No.: Production Cast Weight: 5,17
Description: Cast iron Grate 52.50 E / F		
Scale: 1:2		Author: HK d. 6. september 2016
Sheet: A3 Page 1 of 1		This drawing is the property of POLYSAN A/S and may not be lent or copied in whole or in part without written permission.
		Industrivej 17 DK-5672 Broby TLF: +45 62 66 12 21 FAX: +45 62 66 15 21